



# Cambridge IGCSE™

---

## PHYSICS

0625/11

Paper 1 Multiple Choice (Core)

October/November 2023

45 minutes

You must answer on the multiple choice answer sheet.

You will need: Multiple choice answer sheet  
Soft clean eraser  
Soft pencil (type B or HB is recommended)

---

## INSTRUCTIONS

- There are **forty** questions on this paper. Answer **all** questions.
- For each question there are four possible answers **A**, **B**, **C** and **D**. Choose the **one** you consider correct and record your choice in soft pencil on the multiple choice answer sheet.
- Follow the instructions on the multiple choice answer sheet.
- Write in soft pencil.
- Write your name, centre number and candidate number on the multiple choice answer sheet in the spaces provided unless this has been done for you.
- Do **not** use correction fluid.
- Do **not** write on any bar codes.
- You may use a calculator.
- Take the weight of 1.0 kg to be 9.8 N (acceleration of free fall =  $9.8 \text{ m/s}^2$ ).

## INFORMATION

- The total mark for this paper is 40.
- Each correct answer will score one mark.
- Any rough working should be done on this question paper.

---

This document has **16** pages. Any blank pages are indicated.



## 2

- 1 In order to determine the period of a pendulum, a student times one complete swing of the pendulum using an analogue stop-watch with a second hand.

Which change of method produces the greatest improvement in accuracy?

- A asking a friend with a shorter reaction time to take the measurement
  - B measuring the time for 100 swings of the pendulum and dividing it by 100
  - C measuring the time for a half swing of the pendulum and doubling it
  - D using a digital timer
- 2 The graph shows the speed of a car travelling through a town.

Which section of the graph represents a period when the car is decelerating?

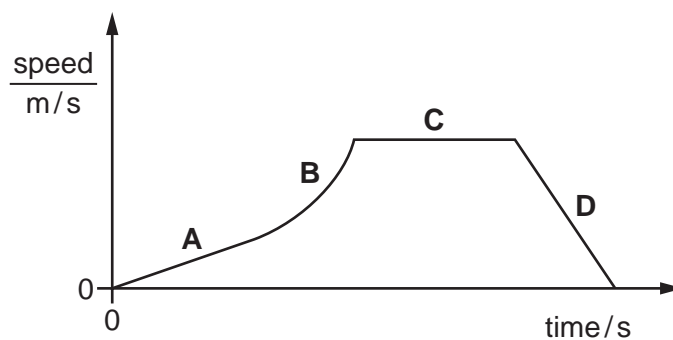

- 3 An object weighs 19 N on a planet where the acceleration of free fall is  $3.8 \text{ m/s}^2$ .

What is the mass of the object?

- A 0.20 kg
- B 1.9 kg
- C 5.0 kg
- D 72 kg

- 4 An object is suspended from a spring balance on the Earth. The same object is suspended from the same spring balance on another planet.

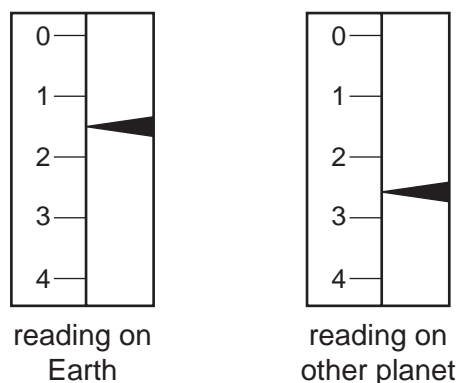

Which statement explains the difference between the two readings?

- A** Both the mass and the weight of the object are greater on the other planet.
- B** The mass of the object is greater on the other planet than on the Earth, but the weight is unchanged.
- C** The spring stretches more easily when on the other planet.
- D** The weight of the object is greater on the other planet than on the Earth, but the mass is unchanged.
- 5 A student has a bottle of cooking oil.

She determines the density of the cooking oil.

Which apparatus does she need?

	balance	measuring cylinder	ruler	thermometer
<b>A</b>	✓	✓	✓	✓
<b>B</b>	✓	✓	✓	x
<b>C</b>	✓	✓	x	x
<b>D</b>	✓	x	x	x

key

✓ = needed

x = not needed

- 6 Forces are applied to four identical objects.

The length of each arrow indicates the magnitude of the force.

Which object is in equilibrium?

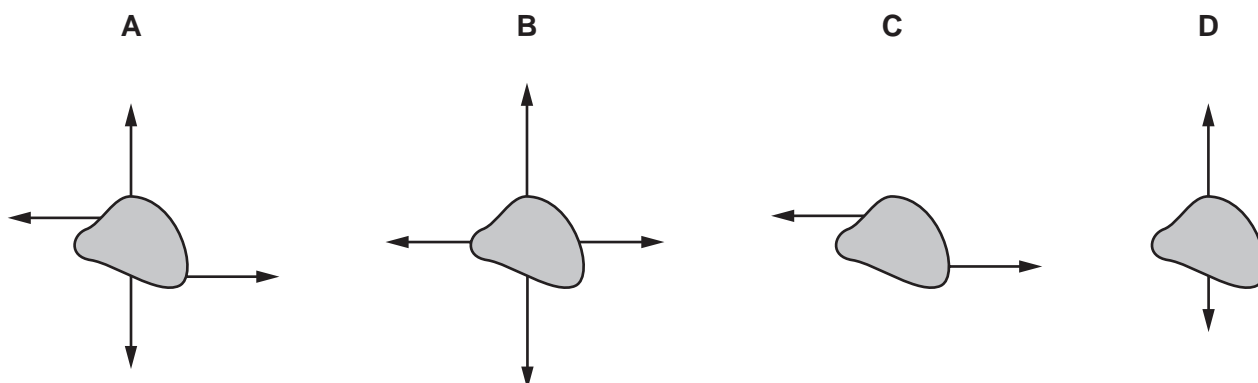

- 7 The diagram shows a wooden beam PQ which is attached to a wall by a pivot at P and kept in a horizontal position by a vertical rope attached at Q.

A box has been placed on the beam.

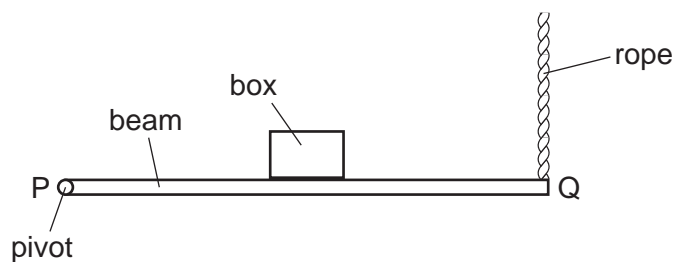

Which changes **must** reduce the tension in the rope at Q?

- A Decrease the mass of the box and move it towards P.
- B Decrease the mass of the box and move it towards Q.
- C Increase the mass of the box and move it towards P.
- D Increase the mass of the box and move it towards Q.

- 8 A cyclist travels down a hill from rest at point X without pedalling.

The cyclist applies his brakes and the cycle stops at point Y.

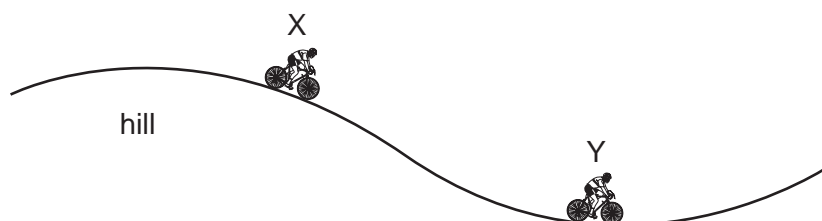

Which energy transfers have taken place between X and Y?

- A** gravitational potential → kinetic → internal (thermal)  
**B** gravitational potential → internal (thermal) → kinetic  
**C** kinetic → gravitational potential → internal (thermal)  
**D** kinetic → internal (thermal) → gravitational potential
- 9 Which energy resource is non-renewable?
- A** geothermal  
**B** natural gas  
**C** solar  
**D** wind
- 10 A pump does 460 000 J of work to raise water to fill a tank. It takes 7 minutes to fill the tank.
- What is the power of the pump?
- A** 1.1 kW      **B** 66 kW      **C** 3200 kW      **D** 190 000 kW
- 11 When a diver swims down from the surface of the water to a depth of 10 m, the pressure experienced increases from 100 000 N/m<sup>2</sup> to 200 000 N/m<sup>2</sup>.
- Which statement explains this increase in pressure?
- A** The density of the water increases with depth.  
**B** The gravitational field strength increases with depth.  
**C** The weight of water above the diver increases with depth.  
**D** Water cannot be compressed.

12 Why can a gas be compressed easily into a smaller volume?

- A The particles are far apart.
- B The particles do not attract each other.
- C The particles move randomly.
- D The volume of each particle can be reduced.

13 The melting point of mercury is  $-39^{\circ}\text{C}$ .

What is the melting point of mercury in kelvin?

- A  $-234\text{K}$       B  $61\text{K}$       C  $234\text{K}$       D  $312\text{K}$

14 A bimetallic strip is used to control the temperature of an electrical appliance. It is made of two different metals fixed together.

The diagram shows the shape of the bimetallic strip before and after heating.

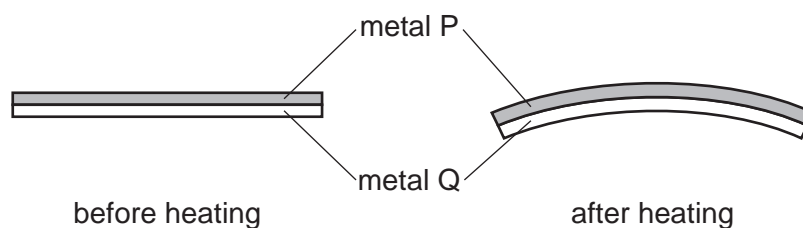

Which statement is correct?

- A Metal P contracts more than metal Q on heating.
- B Metal Q contracts more than metal P on heating.
- C Metal P expands more than metal Q on heating.
- D Metal Q expands more than metal P on heating.

- 15 A student has two blocks of metal, X and Y. The temperature of X is  $50^{\circ}\text{C}$  and the temperature of Y is  $0^{\circ}\text{C}$ .

The two blocks are placed in contact with each other, as shown.

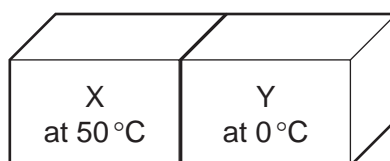

After some time, both blocks have a temperature of  $25^{\circ}\text{C}$ .

What has happened to the internal energy of each block?

	internal energy of X	internal energy of Y
<b>A</b>	decreased	decreased
<b>B</b>	decreased	increased
<b>C</b>	increased	decreased
<b>D</b>	unchanged	unchanged

- 16 The diagram shows the view of a room heated by a radiator. The arrowed line from X to Y is the path of the convection current in the air.

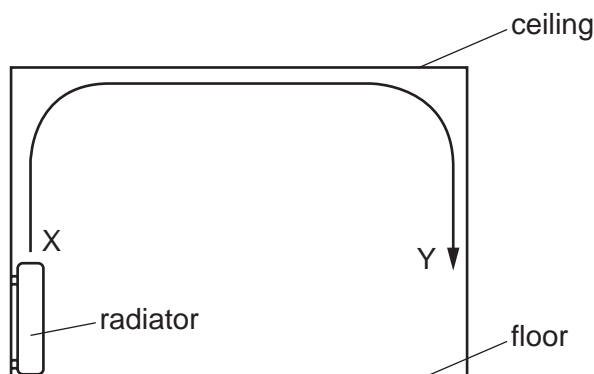

Which row about the air temperature and the air density at X and at Y is correct?

	air temperature	air density
<b>A</b>	higher at X	higher at X
<b>B</b>	higher at X	higher at Y
<b>C</b>	higher at Y	higher at Y
<b>D</b>	higher at Y	higher at X

17 Which statements about waves are correct?

- 1 Only longitudinal waves can undergo diffraction.
- 2 All waves can undergo refraction.
- 3 All waves can undergo reflection.

**A** 1, 2 and 3    **B** 1 and 2 only    **C** 1 and 3 only    **D** 2 and 3 only

18 Which quantities relating to a wave on the surface of water can **both** be measured in metres?

- A** amplitude and frequency
- B** amplitude and wavelength
- C** amplitude and wave speed
- D** frequency and wavelength

19 Which diagram correctly shows the dispersion of white light through a glass prism?

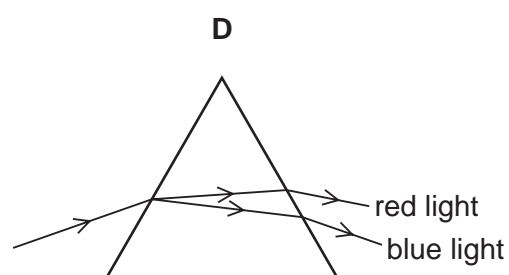
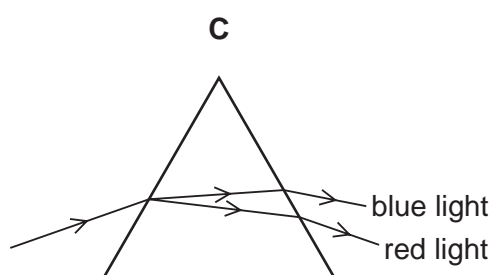
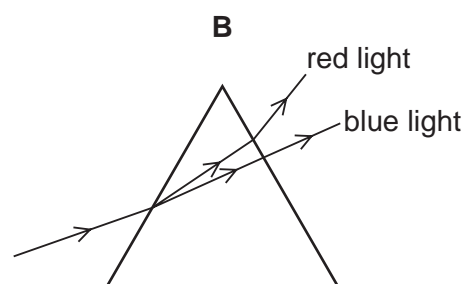
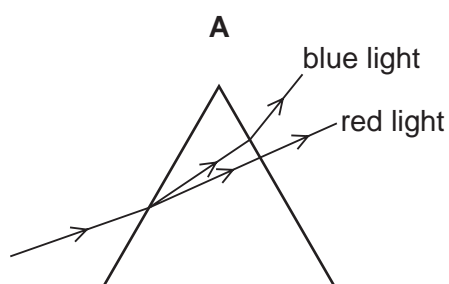



20 A ray of light is reflected by a plane mirror.

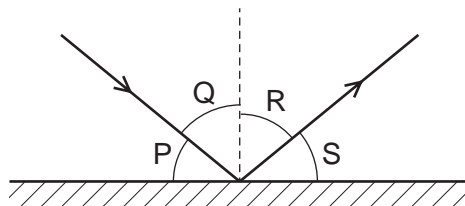

Which row shows the angle of incidence and the angle of reflection?

	angle of incidence	angle of reflection
<b>A</b>	P	Q
<b>B</b>	P	S
<b>C</b>	Q	R
<b>D</b>	R	S

21 A thin converging lens is used to produce a real image of an object.

Which statement about the real image is always correct?

- A** It is nearer to the lens than the object.
- B** It is on the opposite side of the lens to the object.
- C** It is the same size as the object.
- D** It is upright.

22 Where do all types of electromagnetic waves travel at the same speed?

- A** air
- B** a vacuum
- C** glass
- D** water

23 Dogs can hear sounds in the range from 100 Hz to 45 kHz.

Which statement is correct?

- A** Any sound a dog can hear can also be heard by a human.
- B** Any sound a human can hear can also be heard by a dog.
- C** Dogs can hear some low frequency sounds that are silent for humans.
- D** Dogs can hear some high frequency sounds that are silent for humans.

- 24 Which metal could be used for a permanent magnet and which metal could be used for the core of an electromagnet?

	permanent magnet	core of electromagnet
<b>A</b>	iron	copper
<b>B</b>	iron	steel
<b>C</b>	steel	copper
<b>D</b>	steel	iron

- 25 Object 1 is given a negative charge and placed on a balance.

Object 2, which is also charged, is brought close to object 1 and the reading on the balance changes as shown.

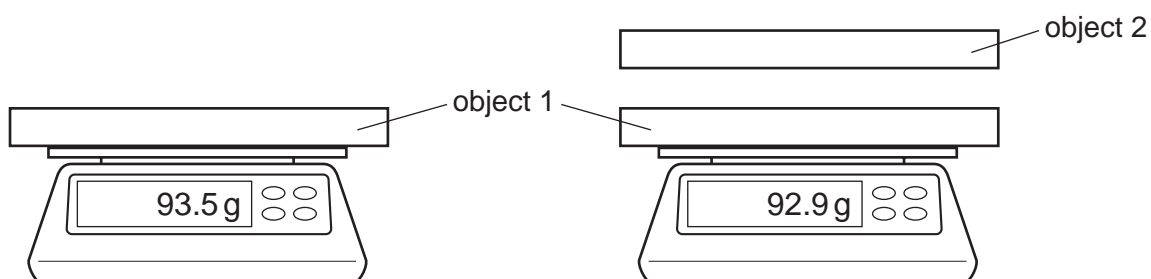

Which action would further decrease the reading on the balance?

- A** Add the same number of electrons to both objects.
  - B** Remove the same number of electrons from both objects.
  - C** Transfer electrons from object 1 to object 2.
  - D** Transfer electrons from object 2 to object 1.
- 26 Which statement about a voltmeter is correct?
- A** It has a scale which is marked in amperes (A).
  - B** It must be connected in series in a circuit.
  - C** It measures potential difference (p.d.).
  - D** It must have three terminals.

27 How does the resistance of a metallic wire change:

- as its length increases
- as its cross-sectional area decreases?

	resistance as length increases	resistance as cross-sectional area decreases
<b>A</b>	decreases	decreases
<b>B</b>	decreases	increases
<b>C</b>	increases	decreases
<b>D</b>	increases	increases

28 A plastic rod is rubbed with a cloth. The rod becomes positively charged because of the movement of charged particles.

Which row gives the name of these charged particles and the direction in which they move?

	charged particles	direction of movement
<b>A</b>	electrons	from cloth to rod
<b>B</b>	electrons	from rod to cloth
<b>C</b>	protons	from cloth to rod
<b>D</b>	protons	from rod to cloth

29 Two  $2.0\ \Omega$  resistors are connected in parallel.

What is the combined resistance of the resistors?

- A** less than  $2.0\ \Omega$
- B** exactly  $2.0\ \Omega$
- C** more than  $2.0\ \Omega$ , but less than  $4.0\ \Omega$
- D** exactly  $4.0\ \Omega$

**30** An electric heater is plugged into the mains supply using a fused plug.

The current in the heater is 10 A.

The cable attached to the heater is rated at 15 A.

The fuses available are rated at 1.0 A, 3.0 A, 5.0 A and 13 A.

Which fuse should be used?

- A** 1.0 A      **B** 3.0 A      **C** 5.0 A      **D** 13 A

**31** A teacher sets up the equipment for three demonstrations, P, Q and R.

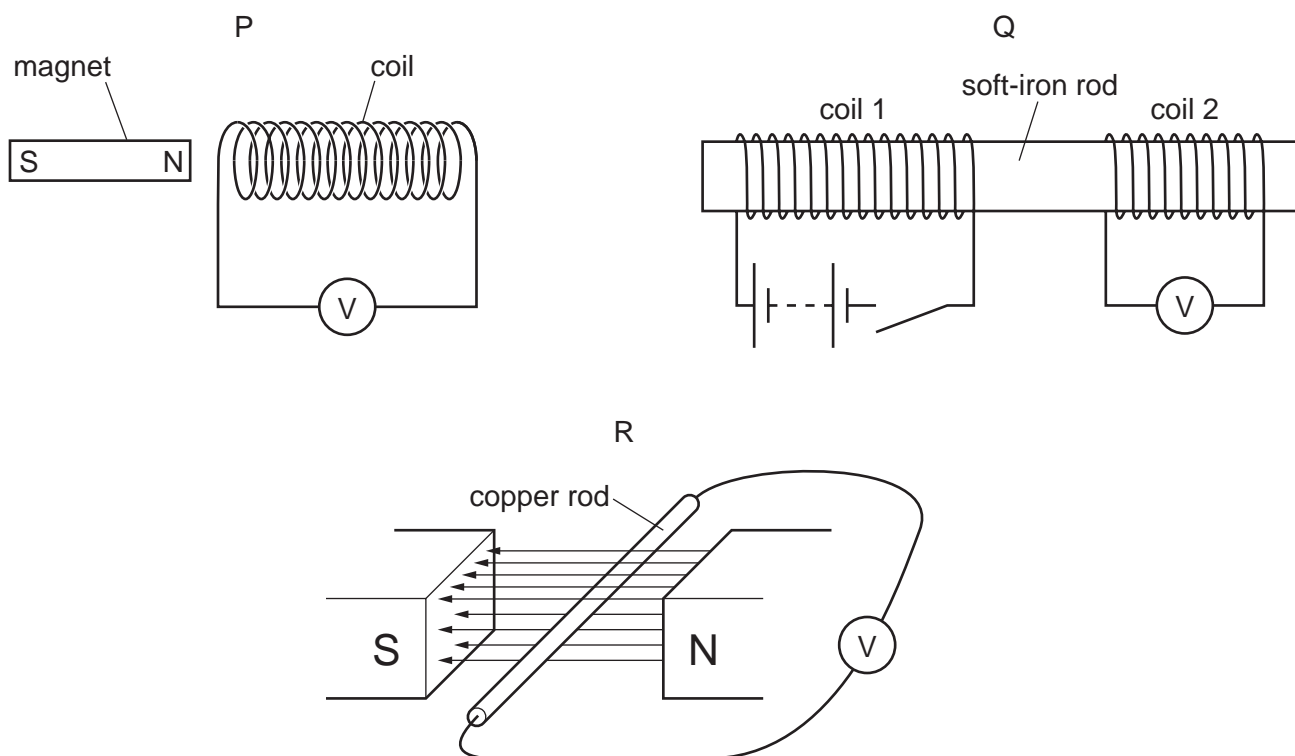

In demonstration P, the magnet is moved to the right.

In demonstration Q, the switch is closed.

In demonstration R, the copper rod is moved vertically upwards.

Which demonstrations can be used to demonstrate electromagnetic induction?

- A** P and Q only    **B** P and R only    **C** Q and R only    **D** P, Q and R

- 32 A metal rod PQ rests on two horizontal metal wires that are attached to a battery. The rod lies between the poles of a magnet.

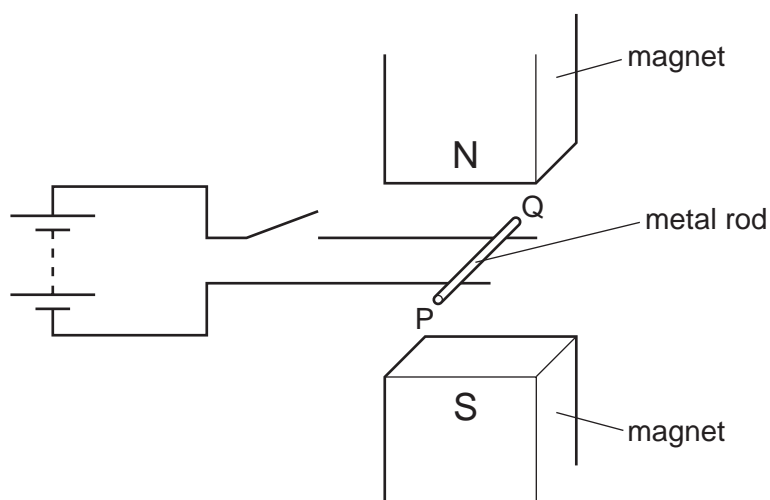

When the switch is closed, the rod moves to the right.

What could be changed so that the rod moves to the left?

- A Open the switch.
  - B Reverse the battery terminals and exchange the poles of the magnet.
  - C Reverse the battery terminals but without exchanging the poles of the magnet.
  - D Turn the metal rod around (P and Q exchanged).
- 33 A transformer in a computer is used to transform the mains voltage of 240 V to 12 V.

The number of turns on the secondary coil is 2000.

Which statement about the transformer is correct?

- A It is a step-down transformer and has 100 turns on its primary coil.
- B It is a step-down transformer and has 40 000 turns on its primary coil.
- C It is a step-up transformer and has 100 turns on its primary coil.
- D It is a step-up transformer and has 40 000 turns on its primary coil.

- 34 Atom P has 6 electrons, 6 protons and 6 neutrons.

Atom Q has 6 electrons, 6 protons and 7 neutrons.

Which statement is correct?

- A Atom P has atomic number 12.
- B Atom P has nucleon number 6.
- C Atom Q has nucleon number 13.
- D Atoms P and Q are different chemical elements.

- 35  $\alpha$ -particles,  $\beta$ -particles and  $\gamma$ -rays are emitted by radioactive nuclei when they decay.

Which emissions can be deflected by an electric field?

- A  $\alpha$ -particles,  $\beta$ -particles and  $\gamma$ -rays
- B  $\alpha$ -particles and  $\beta$ -particles only
- C  $\beta$ -particles and  $\gamma$ -rays only
- D  $\gamma$ -rays and  $\alpha$ -particles only

- 36 The graph shows the count rate from a radioactive source over a period of time.

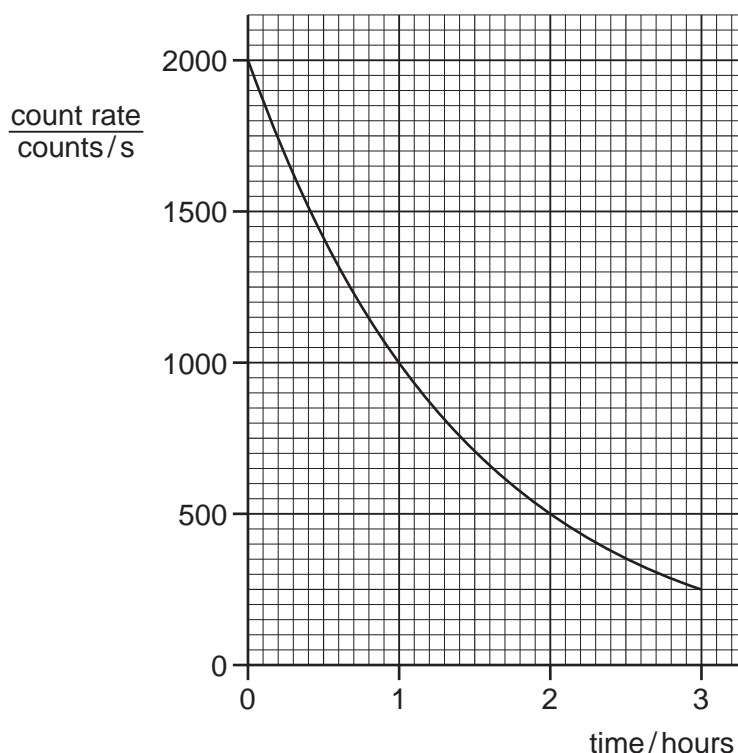

What is the half-life of the source?

- A 0.5 hour
  - B 1.0 hour
  - C 1.5 hours
  - D 3.0 hours
- 37 A scientist carries out an experiment using a sealed source which emits  $\beta$ -particles. The range of the  $\beta$ -particles in the air is about 30 cm.

Which precaution is the most effective to protect the scientist from the radiation?

- A handling the source with long tongs
- B keeping the temperature of the source low
- C opening all windows in the laboratory
- D washing his hands before leaving the laboratory

- 38** Which planet orbits the Sun between Mars and Saturn?
- A** Earth
  - B** Jupiter
  - C** Mercury
  - D** Neptune
- 39** Which statement about the Sun is correct?
- A** The Sun is a dwarf star consisting mostly of hydrogen and oxygen.
  - B** The Sun is a giant star consisting mostly of helium and carbon dioxide.
  - C** The Sun is a medium-sized star consisting mostly of hydrogen and helium.
  - D** The Sun is a medium-sized star consisting mostly of nitrogen and oxygen.
- 40** Which quantity does a light-year measure?
- A** an angle
  - B** a distance
  - C** a speed
  - D** a time

**BLANK PAGE**

---

Permission to reproduce items where third-party owned material protected by copyright is included has been sought and cleared where possible. Every reasonable effort has been made by the publisher (UCLES) to trace copyright holders, but if any items requiring clearance have unwittingly been included, the publisher will be pleased to make amends at the earliest possible opportunity.

To avoid the issue of disclosure of answer-related information to candidates, all copyright acknowledgements are reproduced online in the Cambridge Assessment International Education Copyright Acknowledgements Booklet. This is produced for each series of examinations and is freely available to download at [www.cambridgeinternational.org](http://www.cambridgeinternational.org) after the live examination series.

Cambridge Assessment International Education is part of Cambridge Assessment. Cambridge Assessment is the brand name of the University of Cambridge Local Examinations Syndicate (UCLES), which is a department of the University of Cambridge.